

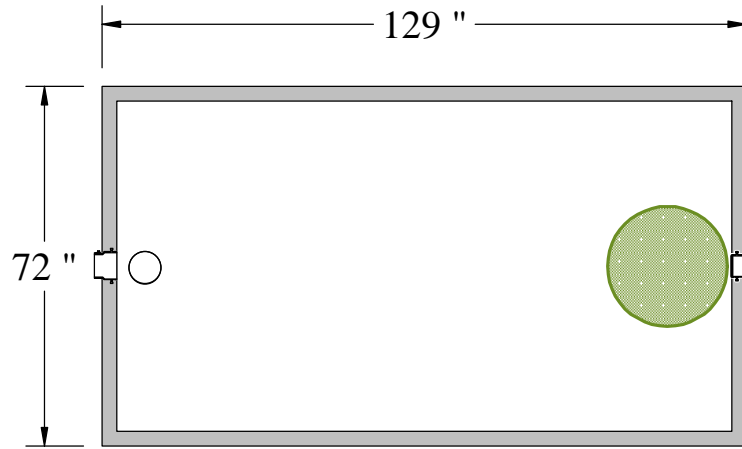

12980 lbs.

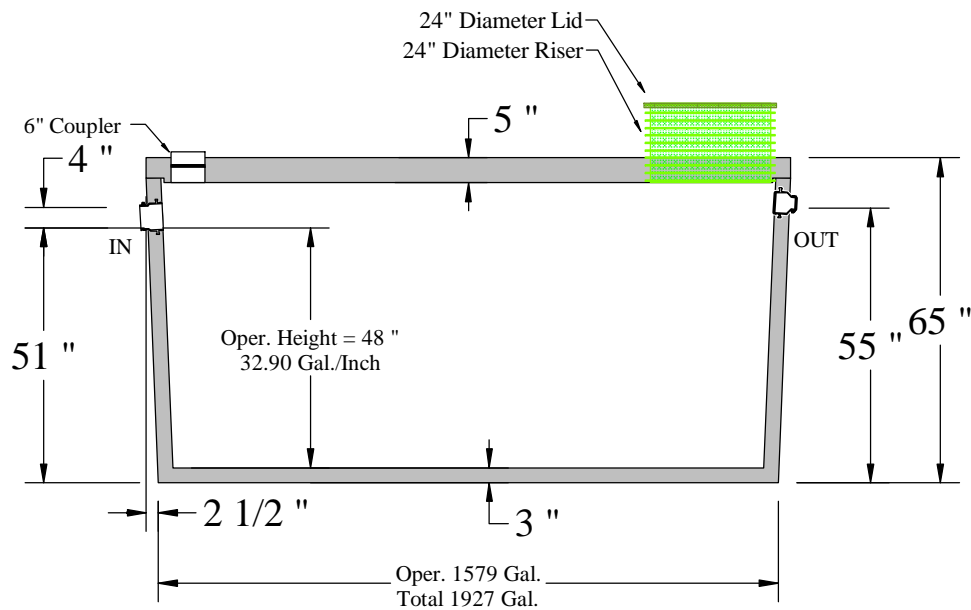

TOP VIEW



SIDE VIEW

General Notes

- Standard inlet is 4" diameter - Outlet is 2" diameter
- Pipe penetrations are flexible watertight seals with clamps for pipe
- Typical access holes are 24" diameter ribbed pipe with screwed watertight gasketed lids
- Joint between the tank and tank top is sealed with Con-Seal CS-665 mastic rope or equal
- Concrete shall be 4000 psi within 28 days
- Rebar shall meet ASTM A 615 grade 60 specifications
- Wire mesh shall meet ASTM A-185 grade 65 specifications
- Fibermesh reinforcing shall meet ASTM C1116

BODE'S PRECAST, INC.
1861 East Pole Rd.
Everson, Wa. 98247
(360) 354-3912

1500 Gallon Pump Tank
1 Chamber

Model Number: P1500

Date Issued: November 2010